

## FEATURES

- **One External Resistor Sets the Frequency**
- **Fast Start-Up Time: <1ms**
- **1kHz to 33MHz Frequency Range**
- Frequency Error  $\leq 1.5\%$  5kHz to 20MHz ( $T_A = 25^\circ\text{C}$ )
- Frequency Error  $\leq 2\%$  5kHz to 20MHz ( $T_A = 0^\circ\text{C}$  to  $70^\circ\text{C}$ )
- $\pm 40\text{ppm}/^\circ\text{C}$  Temperature Stability
- 0.05%/V Supply Stability
- 50%  $\pm 1\%$  Duty Cycle 1kHz to 2MHz
- 50%  $\pm 5\%$  Duty Cycle 2MHz to 20MHz
- 1mA Typical Supply Current
- 100 $\Omega$  CMOS Output Driver
- Operates from a Single 2.7V to 5.5V Supply
- Low Profile (1mm) SOT-23 (ThinSOT™ Package)

## APPLICATIONS

- Low Cost Precision Oscillator
- Charge Pump Driver
- Switching Power Supply Clock Reference
- Clocking Switched Capacitor Filters
- Fixed Crystal Oscillator Replacement
- Ceramic Oscillator Replacement
- Small Footprint Replacement for Econ Oscillators

LT, LT, LTC, LTM, Linear Technology and the Linear logo are registered trademarks and ThinSOT is a trademark of Linear Technology Corporation. All other trademarks are the property of their respective owners. Protected by U.S. Patents including 6342817 and 6614313.

## DESCRIPTION

The LTC<sup>®</sup>1799 is a precision oscillator that is easy to use and occupies very little PC board space. The oscillator frequency is programmed by a single external resistor ( $R_{\text{SET}}$ ). The LTC1799 has been designed for high accuracy operation ( $\leq 1.5\%$  frequency error) without the need for external trim components.

The LTC1799 operates with a single 2.7V to 5.5V power supply and provides a rail-to-rail, 50% duty cycle square wave output. The CMOS output driver ensures fast rise/fall times and rail-to-rail switching. The frequency-setting resistor can vary from 3k to 1M to select a master oscillator frequency between 100kHz and 33MHz (5V supply). The three-state DIV input determines whether the master clock is divided by 1, 10 or 100 before driving the output, providing three frequency ranges spanning 1kHz to 33MHz (5V supply). The LTC1799 features a proprietary feedback loop that linearizes the relationship between  $R_{\text{SET}}$  and frequency, eliminating the need for tables to calculate frequency. The oscillator can be easily programmed using the simple formula outlined below:

$$f_{\text{OSC}} = 10\text{MHz} \cdot \left( \frac{10\text{k}}{N \cdot R_{\text{SET}}} \right), N = \begin{cases} 100, & \text{DIV Pin} = V^+ \\ 10, & \text{DIV Pin} = \text{Open} \\ 1, & \text{DIV Pin} = \text{GND} \end{cases}$$

## TYPICAL APPLICATION

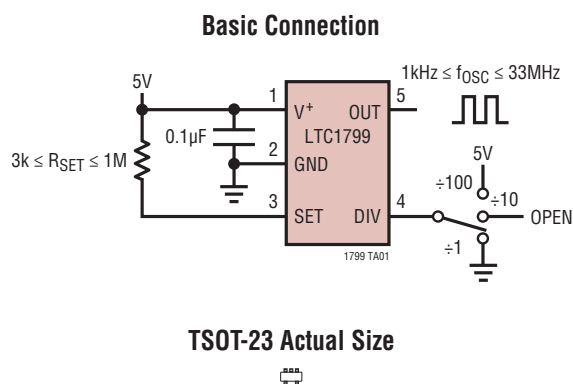

**Typical Distribution of Frequency Error,**  
 $T_A = 25^\circ\text{C}$  ( $5\text{kHz} \leq f_{\text{OSC}} \leq 20\text{MHz}$ ,  $V^+ = 5\text{V}$ )

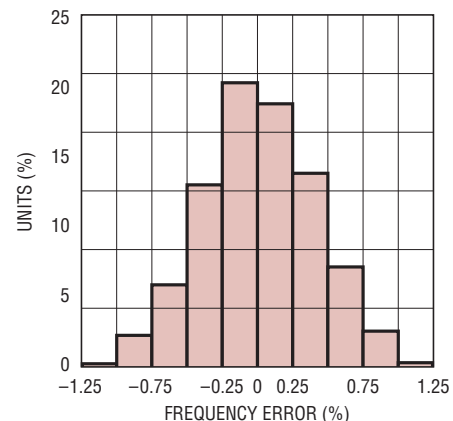

1799 TA02

1799fc

# LTC1799

## ABSOLUTE MAXIMUM RATINGS

(Note 1)

Supply Voltage ( $V^+$ ) to GND .....	-0.3V to 6V
DIV to GND .....	-0.3V to ( $V^+ + 0.3V$ )
SET to GND .....	-0.3V to ( $V^+ + 0.3V$ )
Operating Temperature Range	
LTC1799C .....	0°C to 70°C
LTC1799I .....	-40°C to 85°C
LTC1799H .....	-40°C to 125°C
Storage Temperature Range .....	-65°C to 150°C
Lead Temperature (Soldering, 10 sec).....	300°C

## PIN CONFIGURATION

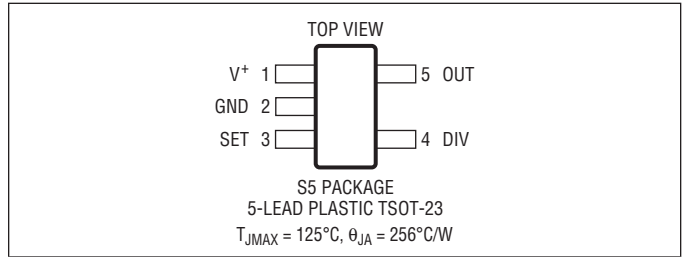

## ORDER INFORMATION

LEAD FREE FINISH	TAPE AND REEL	PART MARKING*	PACKAGE DESCRIPTION	TEMPERATURE RANGE
LTC1799CS5#PBF	LTC1799CS5#TRPBF	LTND	5-Lead Plastic TSOT-23	0°C to 70°C
LTC1799IS5#PBF	LTC1799IS5#TRPBF	LTNE	5-Lead Plastic TSOT-23	-40°C to 85°C
LTC1799HS5#PBF	LTC1799HS5#TRPBF	LTND	5-Lead Plastic TSOT-23	-40°C to 125°C

Consult LTC Marketing for parts specified with wider operating temperature ranges. \*The temperature grade is identified by a label on the shipping container. Consult LTC Marketing for information on non-standard lead based finish parts.

For more information on lead free part marking, go to: <http://www.linear.com/leadfree/>

For more information on tape and reel specifications, go to: <http://www.linear.com/tapeandreel/>

## ELECTRICAL CHARACTERISTICS

The ● denotes the specifications which apply over the full operating temperature range, otherwise specifications are at  $T_A = 25^\circ\text{C}$ .  $V^+ = 2.7V$  to  $5.5V$ ,  $R_L = 5k$ ,  $C_L = 5pF$ , unless otherwise noted. All voltages are with respect to GND.

SYMBOL	PARAMETER	CONDITIONS		MIN	TYP	MAX	UNITS
$\Delta f$	Frequency Accuracy  (Notes 2, 3)	$V^+ = 5V$	$5kHz \leq f \leq 20MHz$		$\pm 0.5$	$\pm 1.5$	%
			$5kHz \leq f \leq 20MHz$ , LTC1799C ●			$\pm 2$	%
			$5kHz \leq f \leq 20MHz$ , LTC1799I/H ●			$\pm 2.5$	%
		$V^+ = 3V$	$1kHz \leq f \leq 5kHz$		$\pm 2.5$		%
			$20MHz \leq f \leq 33MHz$		$\pm 2.5$		%
			$5kHz \leq f \leq 10MHz$		$\pm 0.5$	$\pm 1.5$	%
$R_{SET}$	Frequency-Setting Resistor Range	$ \Delta f  < 1.5\%$	$V^+ = 5V$	5		200	$k\Omega$
			$V^+ = 3V$	10		200	$k\Omega$
$f_{MAX}$	Maximum Frequency	$ \Delta f  < 2.5\%$ , Pin 4 = 0V	$V^+ = 5V$		33		MHz
			$V^+ = 3V$		20		MHz
$f_{MIN}$	Minimum Frequency	$ \Delta f  < 2.5\%$ , Pin 4 = $V^+$			1		kHz
$\Delta f/\Delta T$	Freq Drift Over Temp (Note 3)	$R_{SET} = 31.6k$			$\pm 0.004$		%/ $^\circ\text{C}$
$\Delta f/\Delta V$	Freq Drift Over Supply (Note 3)	$V^+ = 3V$ to $5V$ , $R_{SET} = 31.6k$			0.05	0.1	%/V
					0.06		%
	Timing Jitter (Note 4)	Pin 4 = $V^+$			0.13		%
		Pin 4 = Open			0.4		%
		Pin 4 = 0V					
	Long-Term Stability of Output Frequency				300		ppm/ $\sqrt{kHr}$

1799fc

## ELECTRICAL CHARACTERISTICS

The ● denotes the specifications which apply over the full operating temperature range, otherwise specifications are at  $T_A = 25^\circ\text{C}$ .  $V^+ = 2.7\text{V}$  to  $5.5\text{V}$ ,  $R_L = 5\text{k}$ ,  $C_L = 5\text{pF}$ , unless otherwise noted. All voltages are with respect to GND.

SYMBOL	PARAMETER	CONDITIONS		MIN	TYP	MAX	UNITS
	Duty Cycle (Note 7)	Pin 4 = $V^+$ or Open (DIV Either by 100 or 10)		● 49	50	51	%
		Pin 4 = $0\text{V}$ (DIV by 1), $R_{\text{SET}} = 5\text{k}$ to $200\text{k}$		● 45	50	55	%
$V^+$	Operating Supply Range			● 2.7		5.5	V
$I_S$	Power Supply Current	$R_{\text{SET}} = 200\text{k}$ , Pin 4 = $V^+$ , $R_L = \infty$	$V^+ = 5\text{V}$	●	0.7	1.1	mA
		$R_{\text{SET}} = 10\text{k}$ , Pin 4 = $0\text{V}$ , $R_L = \infty$	$V^+ = 5\text{V}$	●		2.4	mA
			$V^+ = 3\text{V}$	●		2	mA
$V_{\text{IH}}$	High Level DIV Input Voltage			● $V^+ - 0.4$			V
$V_{\text{IL}}$	Low Level DIV Input Voltage			●		0.5	V
$I_{\text{DIV}}$	DIV Input Current (Note 5)	Pin 4 = $V^+$	$V^+ = 5\text{V}$	●	5	8	$\mu\text{A}$
		Pin 4 = $0\text{V}$	$V^+ = 5\text{V}$	●	-8	-5	$\mu\text{A}$
$V_{\text{OH}}$	High Level Output Voltage (Note 5)	$V^+ = 5\text{V}$ , LTC1799C/I	$I_{\text{OH}} = -1\text{mA}$	●	4.8	4.95	V
			$I_{\text{OH}} = -4\text{mA}$	●	4.5	4.8	V
		$V^+ = 5\text{V}$ , LTC1799H	$I_{\text{OH}} = -1\text{mA}$	●	4.75	4.95	V
			$I_{\text{OH}} = -4\text{mA}$	●	4.40	4.75	V
$V_{\text{OL}}$	Low Level Output Voltage (Note 5)	$V^+ = 5\text{V}$ , LTC1799C/I	$I_{\text{OL}} = 1\text{mA}$	●	0.05	0.15	V
			$I_{\text{OL}} = 4\text{mA}$	●	0.2	0.4	V
		$V^+ = 5\text{V}$ , LTC1799H	$I_{\text{OL}} = 1\text{mA}$	●	0.05	0.20	V
			$I_{\text{OL}} = 4\text{mA}$	●	0.25	0.50	V
$t_r$	OUT Rise Time (Note 6)	$V^+ = 5\text{V}$	Pin 4 = $V^+$ or Floating, $R_L = \infty$		14		ns
			Pin 4 = $0\text{V}$ , $R_L = \infty$		7		ns
		$V^+ = 3\text{V}$	Pin 4 = $V^+$ or Floating, $R_L = \infty$		19		ns
			Pin 4 = $0\text{V}$ , $R_L = \infty$		11		ns
$t_f$	OUT Fall Time (Note 6)	$V^+ = 5\text{V}$	Pin 4 = $V^+$ or Floating, $R_L = \infty$		13		ns
			Pin 4 = $0\text{V}$ , $R_L = \infty$		6		ns
		$V^+ = 3\text{V}$	Pin 4 = $V^+$ or Floating, $R_L = \infty$		19		ns
			Pin 4 = $0\text{V}$ , $R_L = \infty$		10		ns

**Note 1:** Stresses beyond those listed under Absolute Maximum Ratings may cause permanent damage to the device. Exposure to any Absolute Maximum Rating condition for extended periods may affect device reliability and lifetime.

**Note 2:** Frequencies near 100kHz and 1MHz may be generated using two different values of  $R_{\text{SET}}$  (see the Table 1 in the Applications Information section). For these frequencies, the error is specified under the following assumption:  $10\text{k} < R_{\text{SET}} \leq 100\text{k}$ . The frequency accuracy for  $f_{\text{OSC}} = 20\text{MHz}$  is guaranteed by design and test correlation.

**Note 3:** Frequency accuracy is defined as the deviation from the  $f_{\text{OSC}}$  equation.

**Note 4:** Jitter is the ratio of the peak-to-peak distribution of the period to the mean of the period. This specification is based on characterization and is not 100% tested.

**Note 5:** To conform with the Logic IC Standard convention, current out of a pin is arbitrarily given as a negative value.

**Note 6:** Output rise and fall times are measured between the 10% and 90% power supply levels. These specifications are based on characterization.

**Note 7:** Guaranteed by 5V test.

## TYPICAL PERFORMANCE CHARACTERISTICS

**Frequency Variation vs  $R_{SET}$**

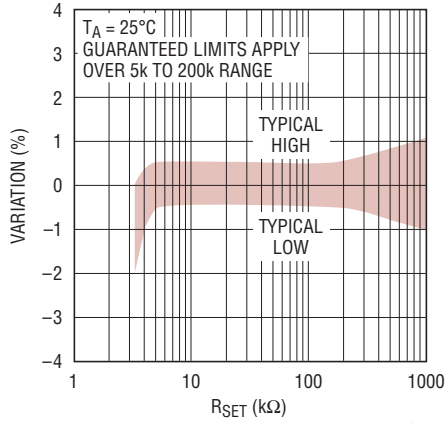

**Frequency Variation Over Temperature**

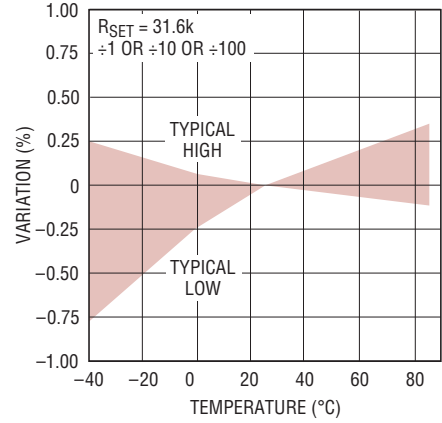

**Peak-to-Peak Jitter vs Frequency**

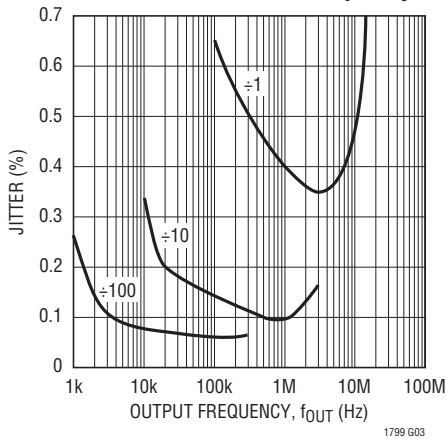

**Supply Current vs Output Frequency**

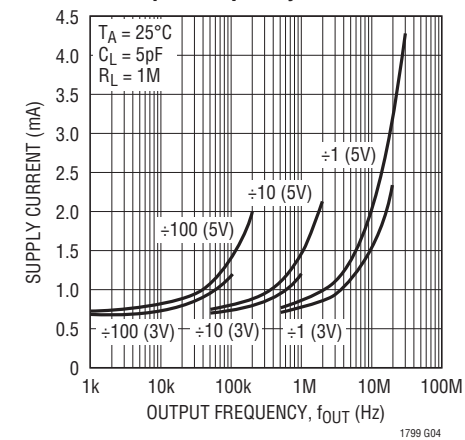

**Output Resistance vs Supply Voltage**

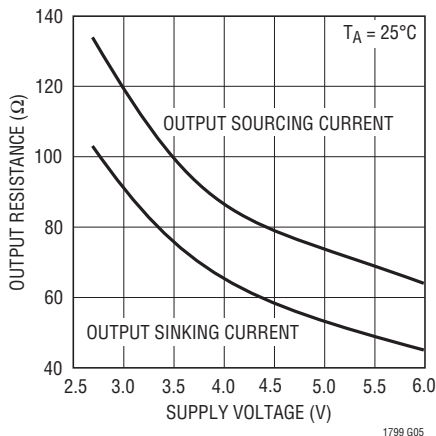

**LTC1799 Output Operating at 20MHz,  $V_S = 5V$**

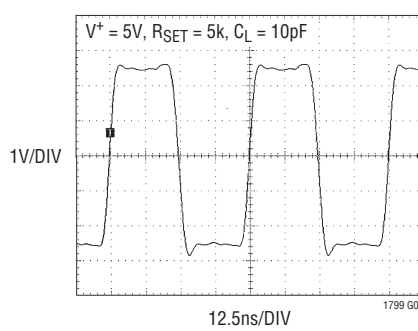

**LTC1799 Output Operating at 10MHz,  $V_S = 3V$**

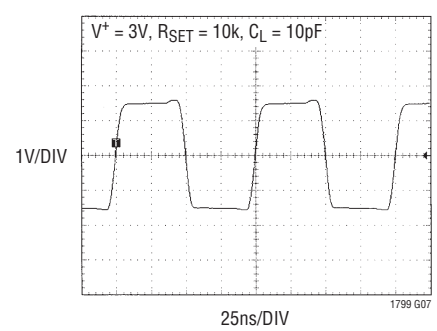

## PIN FUNCTIONS

**V<sup>+</sup> (Pin 1):** Voltage Supply ( $2.7V \leq V^+ \leq 5.5V$ ). This supply must be kept free from noise and ripple. It should be bypassed directly to a ground plane with a  $0.1\mu F$  capacitor.

**GND (Pin 2):** Ground. Should be tied to a ground plane for best performance.

**SET (Pin 3):** Frequency-Setting Resistor Input. The value of the resistor connected between this pin and V<sup>+</sup> determines the oscillator frequency. The voltage on this pin is held by the LTC1799 to approximately 1.13V below the V<sup>+</sup> voltage. For best performance, use a precision metal film resistor with a value between 10k and 200k and limit the capacitance on this pin to less than 10pF.

**DIV (Pin 4):** Divider-Setting Input. This three-state input selects among three divider settings, determining the value of N in the frequency equation. Pin 4 should be tied to GND for the ÷1 setting, the highest frequency range.

Floating Pin 4 divides the master oscillator by 10. Pin 4 should be tied to V<sup>+</sup> for the ÷100 setting, the lowest frequency range. To detect a floating DIV pin, the LTC1799 attempts to pull the pin toward midsupply. This is realized with two internal current sources, one tied to V<sup>+</sup> and Pin 4 and the other one tied to ground and Pin 4. Therefore, driving the DIV pin high requires sourcing approximately 5μA. Likewise, driving DIV low requires sinking 5μA. When Pin 4 is floated, preferably it should be bypassed by a 1nF capacitor to ground or it should be surrounded by a ground shield to prevent excessive coupling from other PCB traces.

**OUT (Pin 5):** Oscillator Output. This pin can drive 5kΩ and/or 10pF loads. Larger loads may cause inaccuracies due to supply bounce at high frequencies. Transients will not cause latchup if the current into/out of the OUT pin is limited to 50mA.

## BLOCK DIAGRAM

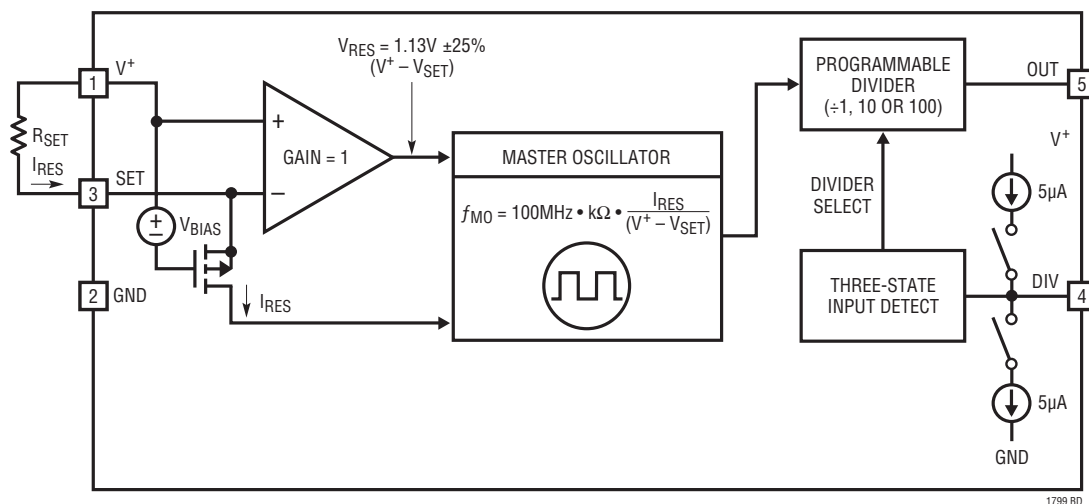

## THEORY OF OPERATION

As shown in the Block Diagram, the LTC1799’s master oscillator is controlled by the ratio of the voltage between the V<sup>+</sup> and SET pins and the current entering the SET pin (I<sub>RES</sub>). The voltage on the SET pin is forced to approximately 1.13V below V<sup>+</sup> by the PMOS transistor and its gate bias voltage. This voltage is accurate to ±7% at a particular input current and supply voltage (see Figure 1). The effective input resistance is approximately 2k.

A resistor R<sub>SET</sub>, connected between the V<sup>+</sup> and SET pins, “locks together” the voltage (V<sup>+</sup> – V<sub>SET</sub>) and current, I<sub>RES</sub>, variation. This provides the LTC1799’s high precision. The master oscillation frequency reduces to:

$$f_{MO} = 10\text{MHz} \cdot \left( \frac{10\text{k}\Omega}{R_{SET}} \right)$$

The LTC1799 is optimized for use with resistors between 10k and 200k, corresponding to master oscillator frequencies between 0.5MHz and 10MHz. Accurate frequencies up to 20MHz (R<sub>SET</sub> = 5k) are attainable if the supply voltage is greater than 4V.

To extend the output frequency range, the master oscillator signal may be divided by 1, 10 or 100 before driving OUT

(Pin 5). The divide-by value is determined by the state of the DIV input (Pin 4). Tie DIV to GND or drive it below 0.5V to select ÷1. This is the highest frequency range, with the master output frequency passed directly to OUT. The DIV pin may be floated or driven to midsupply to select ÷10, the intermediate frequency range. The lowest frequency range, ÷100, is selected by tying DIV to V<sup>+</sup> or driving it to within 0.4V of V<sup>+</sup>. Figure 2 shows the relationship between R<sub>SET</sub>, divider setting and output frequency, including the overlapping frequency ranges near 100kHz and 1MHz.

The CMOS output driver has an on resistance that is typically less than 100Ω. In the ÷1 (high frequency) mode, the rise and fall times are typically 7ns with a 5V supply and 11ns with a 3V supply. These times maintain a clean square wave at 10MHz (20MHz at 5V supply). In the ÷10 and ÷100 modes, where the output frequency is much lower, slew rate control circuitry in the output driver increases the rise/fall times to typically 14ns for a 5V supply and 19ns for a 3V supply. The reduced slew rate lowers EMI (electromagnetic interference) and supply bounce.

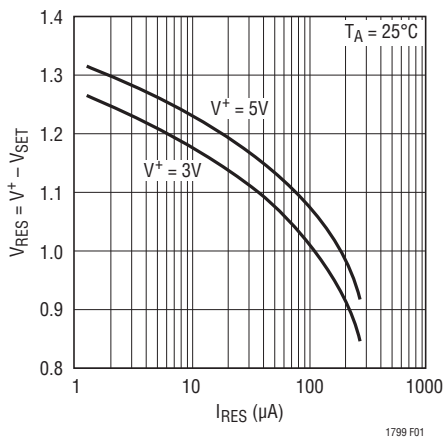

Figure 1. V<sup>+</sup> – V<sub>SET</sub> Variation with I<sub>RES</sub>

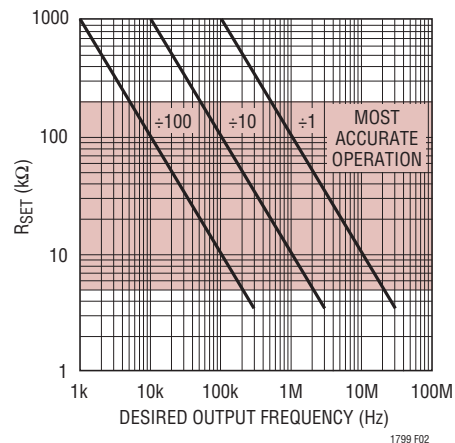

Figure 2. R<sub>SET</sub> vs Desired Output Frequency

## APPLICATIONS INFORMATION

### SELECTING THE DIVIDER SETTING AND RESISTOR

The LTC1799's master oscillator has a frequency range spanning 0.1MHz to 33MHz. However, accuracy may suffer if the master oscillator is operated at greater than 10MHz with a supply voltage lower than 4V. A programmable divider extends the frequency range to greater than three decades. Table 1 describes the recommended frequencies for each divider setting. Note that the ranges overlap; at some frequencies there are two divider/resistor combinations that result in the desired frequency.

In general, any given oscillator frequency ( $f_{OSC}$ ) should be obtained using the lowest master oscillator frequency. Lower master oscillator frequencies use less power and are more accurate. For instance,  $f_{OSC} = 100\text{kHz}$  can be obtained by either  $R_{SET} = 10\text{k}$ ,  $N = 100$ , master oscillator = 10MHz or  $R_{SET} = 100\text{k}$ ,  $N = 10$ , master oscillator = 1MHz. The  $R_{SET} = 100\text{k}$  is preferred for lower power and better accuracy.

**Table 1. Frequency Range vs Divider Setting**

DIVIDER SETTING	FREQUENCY RANGE
$\div 1 \Rightarrow$ DIV (Pin 4) = GND	$>500\text{kHz}^*$
$\div 10 \Rightarrow$ DIV (Pin 4) = Floating	50kHz to 1MHz
$\div 100 \Rightarrow$ DIV (Pin 4) = $V^+$	$<100\text{kHz}$

\*At master oscillator frequencies greater than 10MHz ( $R_{SET} < 10\text{k}\Omega$ ), the LTC1799 may suffer reduced accuracy with a supply voltage less than 4V.

After choosing the proper divider setting, determine the correct frequency-setting resistor. Because of the linear correspondence between oscillation period and resistance, a simple equation relates resistance with frequency.

$$R_{SET} = 10\text{k} \cdot \left( \frac{10\text{MHz}}{N \cdot f_{OSC}} \right), N = \begin{cases} 100 \\ 10 \\ 1 \end{cases}$$

$$(R_{SETMIN} = 3\text{k} \text{ (5V Supply)}, 5\text{k} \text{ (3V Supply)}, \\ R_{SETMAX} = 1\text{M})$$

Any resistor,  $R_{SET}$ , tolerance adds to the inaccuracy of the oscillator,  $f_{OSC}$ .

### ALTERNATIVE METHODS OF SETTING THE OUTPUT FREQUENCY OF THE LTC1799

The oscillator may be programmed by any method that sources a current into the SET pin (Pin 3). The circuit in Figure 3 sets the oscillator frequency using a programmable current source and in the expression for  $f_{OSC}$ , the resistor  $R_{SET}$  is replaced by the ratio of  $1.13\text{V}/I_{CONTROL}$ . As already explained in the "Theory of Operation," the voltage difference between  $V^+$  and SET is approximately 1.13V, therefore, the Figure 3 circuit is less accurate than if a resistor controls the oscillator frequency.

Figure 4 shows the LTC1799 configured as a VCO. A voltage source is connected in series with an external 10k resistor. The output frequency,  $f_{OSC}$ , will vary with  $V_{CONTROL}$ , that is the voltage source connected between  $V^+$  and the SET pin. Again, this circuit decouples the relationship between the input current and the voltage between  $V^+$  and SET; the frequency accuracy will be degraded. The oscillator frequency, however, will monotonically increase with decreasing  $V_{CONTROL}$ .

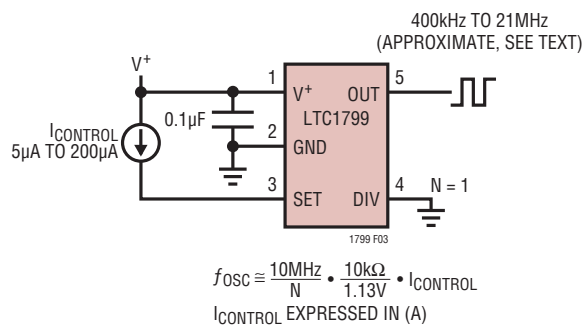

**Figure 3. Current Controlled Oscillator**

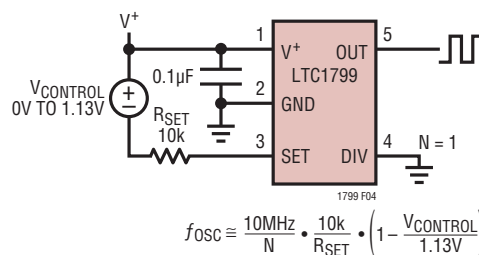

**Figure 4. Voltage Controlled Oscillator**



## APPLICATIONS INFORMATION

### POWER SUPPLY REJECTION

#### Low Frequency Supply Rejection (Voltage Coefficient)

Figure 5 shows the output frequency sensitivity to power supply voltage at several different temperatures. The LTC1799 has a conservative guaranteed voltage coefficient of 0.1%/V but, as Figure 5 shows, the typical supply sensitivity is lower.

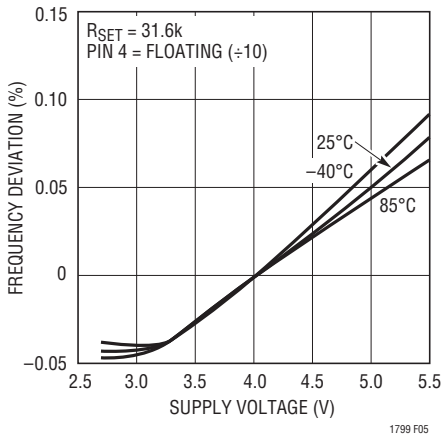

Figure 5. Supply Sensitivity

#### High Frequency Power Supply Rejection

The accuracy of the LTC1799 may be affected when its power supply generates significant noise with frequency contents in the vicinity of the programmed value of  $f_{OSC}$ . If a switching power supply is used to power up the LTC1799, and if the ripple of the power supply is more than a few tens of millivolts, make sure the switching frequency and its harmonics are not related to the output frequency of the LTC1799. Otherwise, the oscillator may show an additional 0.1% to 0.2% of frequency error.

If the LTC1799 is powered by a switching regulator and the switching frequency or its harmonics coincide with the output frequency of the LTC1799, the jitter of the oscillator output may be affected. This phenomenon will become noticeable if the switching regulator exhibits ripples beyond 30mV.

### START-UP TIME

The start-up time and settling time to within 1% of the final value can be estimated by  $t_{START} \cong R_{SET}(2.8\mu s/k\Omega) + 20\mu s$ . Note the start-up time depends on  $R_{SET}$  and it is independent from the setting of the divider pin. For instance with  $R_{SET} = 50k$ , the LTC1799 will settle with 1% of its 200kHz final value ( $N = 10$ ) in approximately 160 $\mu s$ . Figure 6 shows start-up times for various  $R_{SET}$  resistors.

Figure 7 shows an application where a second set resistor  $R_{SET2}$  is connected in parallel with set resistor  $R_{SET1}$  via switch S1. When switch S1 is open, the output frequency of the LTC1799 depends on the value of the resistor  $R_{SET1}$ . When switch S1 is closed, the output frequency of the LTC1799 depends on the value of the parallel combination of  $R_{SET1}$  and  $R_{SET2}$ .

The start-up time and settling time of the LTC1799 with switch S1 open (or closed) is described by  $t_{START}$  shown above. Once the LTC1799 starts and settles, and switch S1 closes (or opens), the LTC1799 will settle to its new output frequency within approximately 25 $\mu s$ .

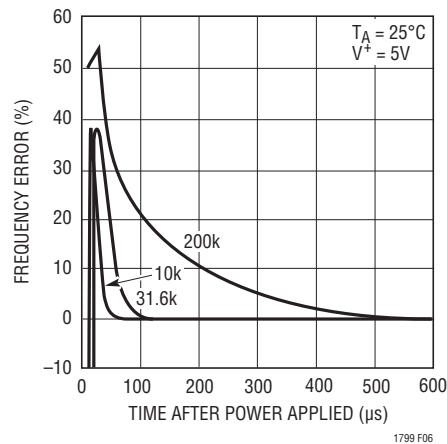

Figure 6. Start-Up Time

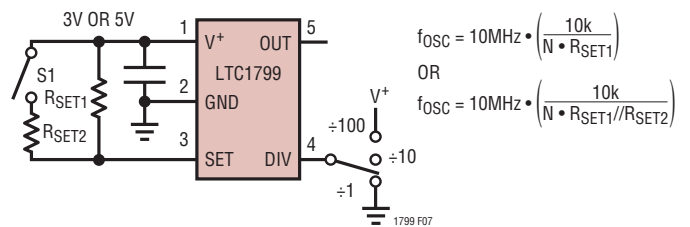

Figure 7



## APPLICATIONS INFORMATION

### Jitter

The typical jitter is listed in the Electrical Characteristics and shown in the Typical Performance Characteristics. These specifications assume that the capacitance on SET (Pin 3) is limited to less than 10pF, as suggested in the Pin Functions description. If this requirement is not met, the jitter will increase. For more information, contact Linear Technology Applications group.

### A Ground Referenced Voltage Controlled Oscillator

The LTC1799 output frequency can also be programmed by steering current in or out of the SET pin, as conceptually shown in Figure 8. This technique can degrade accuracy as the ratio of  $(V^+ - V_{SET}) / I_{RES}$  is no longer uniquely dependent of the value of  $R_{SET}$ , as shown in the LTC1799 Block Diagram. This loss of accuracy will become noticeable when the magnitude of  $I_{PROG}$  is comparable to  $I_{RES}$ . The frequency variation of the LTC1799 is still monotonic.

Figure 9 shows how to implement the concept shown in Figure 8 by connecting a second resistor,  $R_{IN}$ , between the SET pin and a ground referenced voltage source,  $V_{IN}$ .

For a given power supply voltage in Figure 9, the output frequency of the LTC1799 is a function of  $V_{IN}$ ,  $R_{IN}$ ,  $R_{SET}$  and  $(V^+ - V_{SET}) = V_{RES}$ :

$$f_{OSC} = \frac{10\text{MHz}}{N} \cdot \frac{10\text{k}}{R_{IN} \parallel R_{SET}} \cdot \left[ 1 + \frac{(V_{IN} - V^+)}{V_{RES}} \cdot \left( \frac{1}{1 + \frac{R_{IN}}{R_{SET}}} \right) \right] \quad (1)$$

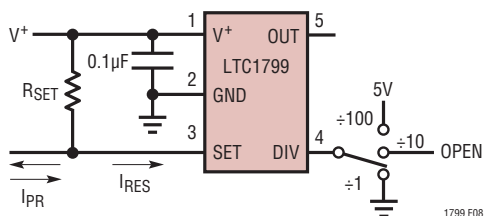

Figure 8. Concept for Programming via Current Steering

When  $V_{IN} = V^+$ , the output frequency of the LTC1799 assumes the highest value and it is set by the parallel combination of  $R_{IN}$  and  $R_{SET}$ . Also note, the output frequency,  $f_{OSC}$ , is independent of the value of  $V_{RES} = (V^+ - V_{SET})$  so the accuracy of  $f_{OSC}$  is within the data sheet limits.

When  $V_{IN}$  is less than  $V^+$ , and especially when  $V_{IN}$  approaches the ground potential, the oscillator frequency,  $f_{OSC}$ , assumes its lowest value and its accuracy is affected by the change of  $V_{RES} = (V^+ - V_{SET})$ . At 25°C  $V_{RES}$  varies by  $\pm 8\%$ , assuming the variation of  $V^+$  is  $\pm 5\%$ . The temperature coefficient of  $V_{RES}$  is 0.02%/°C.

By manipulating the algebraic relation for  $f_{OSC}$  above, a simple algorithm can be derived to set the values of external resistors  $R_{SET}$  and  $R_{IN}$ , as shown in Figure 9.

1. Choose the desired value of the maximum oscillator frequency,  $f_{OSC(MAX)}$ , occurring at maximum input voltage  $V_{IN(MAX)} \leq V^+$ .
2. Set the desired value of the minimum oscillator frequency,  $f_{OSC(MIN)}$ , occurring at minimum input voltage  $V_{IN(MIN)} \geq 0$ .
3. Choose  $V_{RES} = 1.1$  and calculate the ratio of  $R_{IN}/R_{SET}$  from the following:

$$\frac{R_{IN}}{R_{SET}} = \frac{(V_{IN(MAX)} - V^+) - \left( \frac{f_{OSC(MAX)}}{f_{OSC(MIN)}} \right) (V_{IN(MIN)} - V^+)}{V_{RES} \left[ \left( \frac{f_{OSC(MAX)}}{f_{OSC(MIN)}} \right) - 1 \right]} - 1 \quad (2)$$

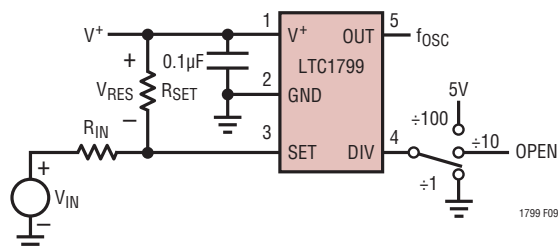

Figure 9. Implementation of Concept Shown in Figure 8

## APPLICATIONS INFORMATION

Once  $R_{IN}/R_{SET}$  is known, calculate  $R_{SET}$  from:

$$R_{SET} = \frac{10\text{MHz}}{N} \cdot \frac{10\text{k}}{f_{OSC(MAX)}} \cdot \left[ \frac{\left( V_{IN(MAX)} - V^+ \right) + V_{RES} \left( 1 + \frac{R_{IN}}{R_{SET}} \right)}{V_{RES} \left( \frac{R_{IN}}{R_{SET}} \right)} \right] \quad (3)$$

### Maximum VCO Modulation Bandwidth

The maximum VCO modulation bandwidth is 10kHz; that is, the LTC1799 will respond to changes in  $V_{IN}$  at a rate up to 25kHz. In lower frequency applications however, the modulation frequency may need to be limited to a lower rate to prevent an increase in output jitter. This lower limit

is the master oscillator frequency divided by 20, ( $f_{OSC}/20$ ). In general, for minimum output jitter the modulation frequency should be limited to  $f_{OSC}/20$  or 10kHz, whichever is less. For best performance at all frequencies, the value for  $f_{OSC}$  should be the master oscillator frequency ( $N = 1$ ) when  $V_{IN}$  is at the lowest level.

**Table 2. Variation of  $V_{RES}$  for Various Values of  $R_{IN} \parallel R_{SET}$**

$R_{IN} \parallel R_{SET} (V_{IN} = V^+)$	$V_{RES}, V^+ = 3V$	$V_{RES}, V^+ = 5V$
10k	0.98V	1.06V
20k	1.03V	1.11V
40k	1.09V	1.17V
80k	1.13V	1.21V
160k	1.16V	1.24V

$V_{RES}$  = Voltage across  $R_{SET}$

**Note:** All of the calculations above assume  $V_{RES} = 1.1V$ , although  $V_{RES} \approx 1.1V$ . For completeness, Table 2 shows the variation of  $V_{RES}$  against various parallel combinations of  $R_{IN}$  and  $R_{SET}$  ( $V_{IN} = V^+$ ). Calculate first with  $V_{RES} \approx 1.1V$ , then use Table 2 to get a better approximation of  $V_{RES}$ , then recalculate the resistor values using the new value for  $V_{RES}$ .

# TYPICAL APPLICATION

Low Power 80Hz to 8kHz Sine Wave Generator ( $I_Q < 4mA$ )

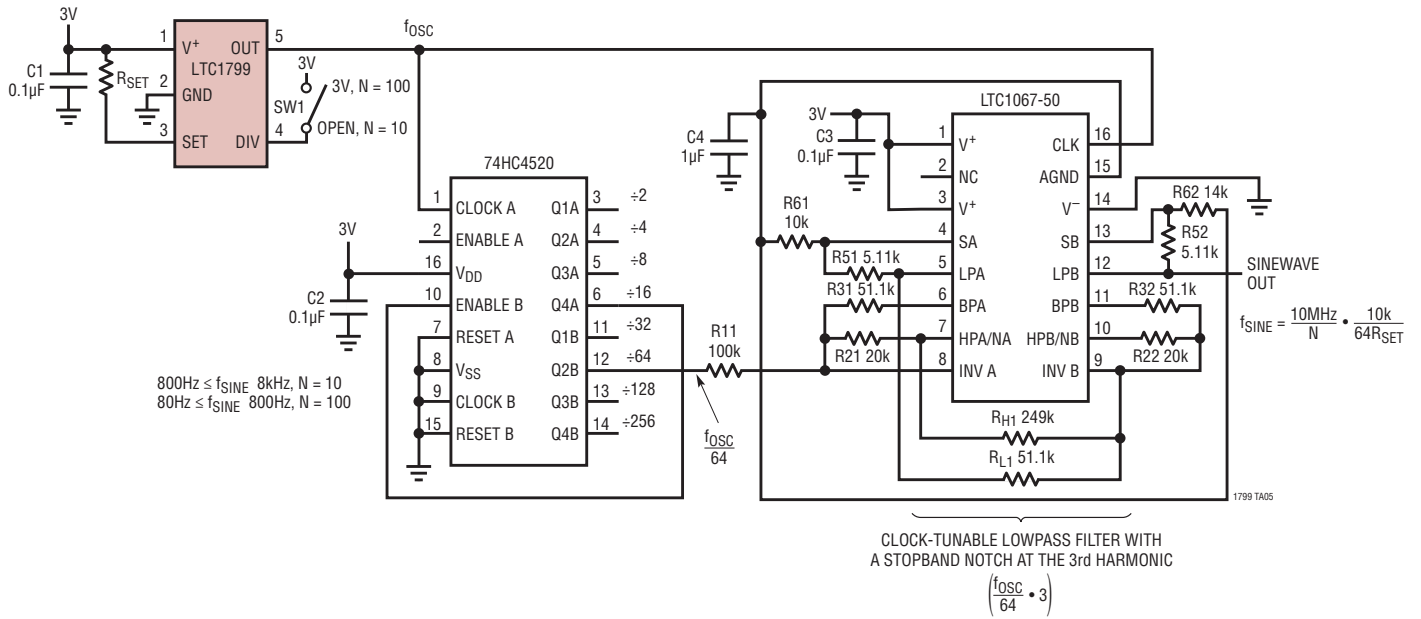

**PACKAGE DESCRIPTION**

**S5 Package**  
**5-Lead Plastic TSOT-23**  
 (Reference LTC DWG # 05-08-1635)

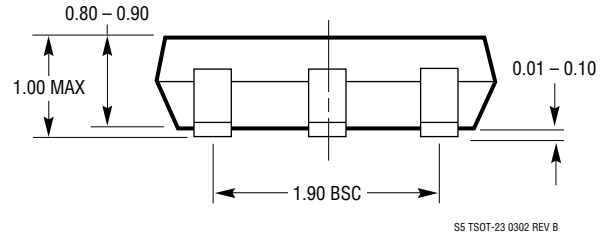
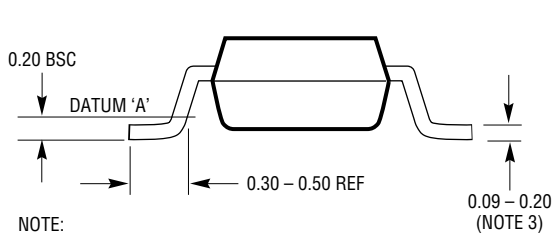
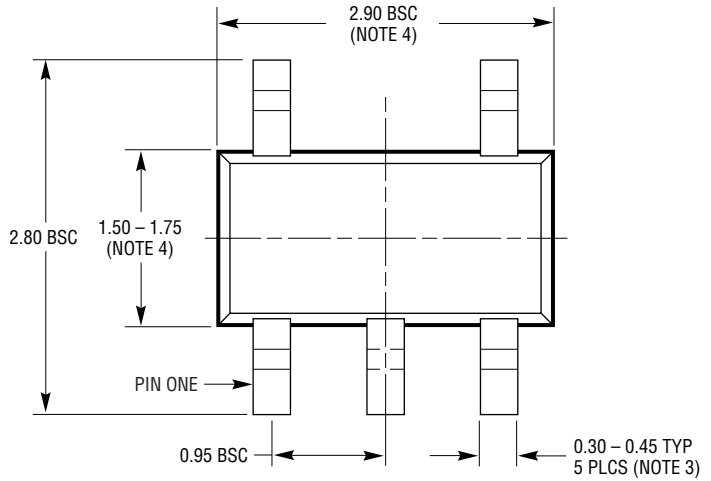
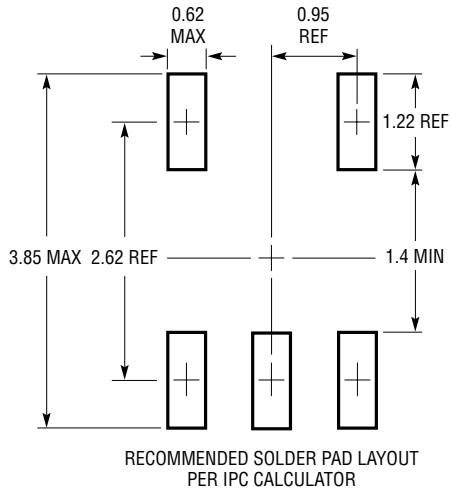

- NOTE:
1. DIMENSIONS ARE IN MILLIMETERS
  2. DRAWING NOT TO SCALE
  3. DIMENSIONS ARE INCLUSIVE OF PLATING
  4. DIMENSIONS ARE EXCLUSIVE OF MOLD FLASH AND METAL BURR
  5. MOLD FLASH SHALL NOT EXCEED 0.254mm
  6. JEDEC PACKAGE REFERENCE IS MO-193

S5 TSOT-23 0302 REV B

**REVISION HISTORY** (Revision history begins at Rev C)

REV	DATE	DESCRIPTION	PAGE NUMBER
C	1/11	Revised part number in Maximum VCO Modulation Bandwidth section.	10

## TYPICAL APPLICATIONS

### Shutting Down the LTC1799

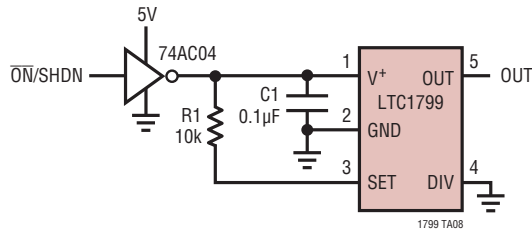

### Temperature-to-Frequency Converter

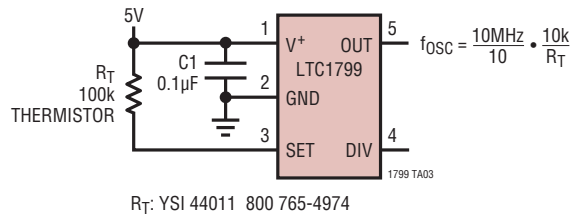

### Output Frequency vs Temperature

